

Design Fact Sheet



Design consultation and illustration

by Hannah Leyland, Intern Architect, B.Sc, M.Arch.

Visit saferbathrooms.ca
for more information
on bathroom safety and
to download resources:



Bathroom safety
assessment
walkthrough
checklist



Safer bathroom
policy and
protocol guide



Examples of
safer bathroom
signage



Mock
overdose response
scenarios

The safer bathrooms toolkit provides a repository of potentially useful documents to assist with communication, training, policy and protocol development, and design. They were developed in 2022 using experiential knowledge, lessons learned in practice, and existing resources. The usefulness of these documents and outcomes may vary depending on the setting. The team responsible for the toolkit's development does not accept legal liability or responsibility for the toolkit or any consequences arising from its use.

Developed with the support of
Michael Smith Health Research BC (Reach Program)



Single-Stall Bathroom

Pull Door (Preferable)

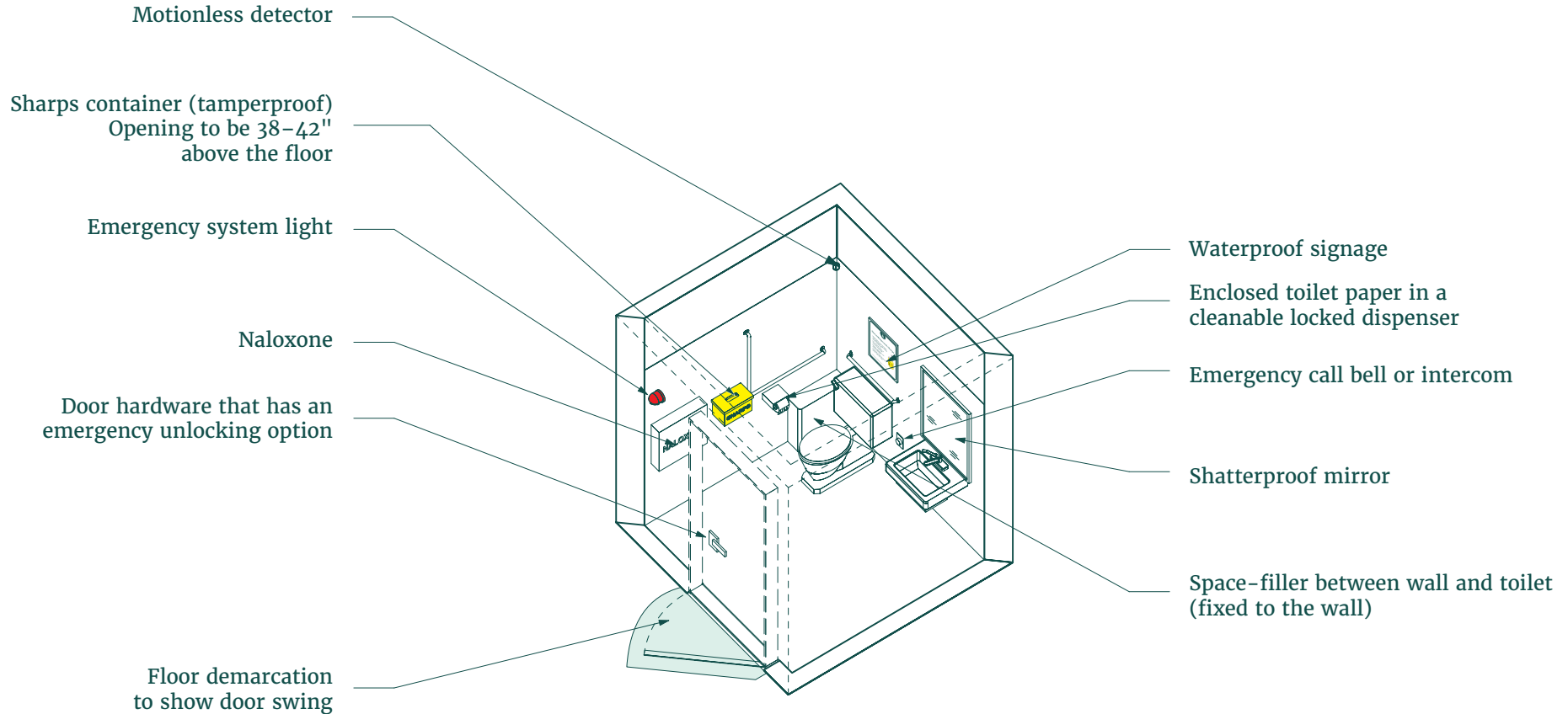

Notes:

All fixture heights, grab bars, door types should conform with local building bylaws.

Items shown pertain to the safer bathroom toolkit, there may be other required items in a bathroom that are not shown here.

Bathroom users should be consulted in design decisions.

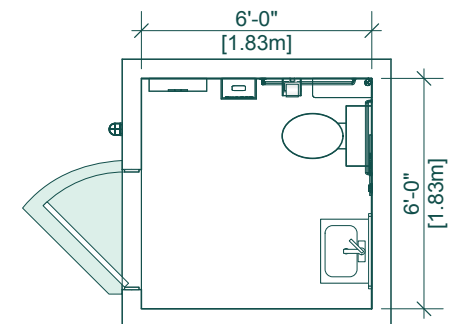

Single Stall Bathroom

Push Door (Alternative)

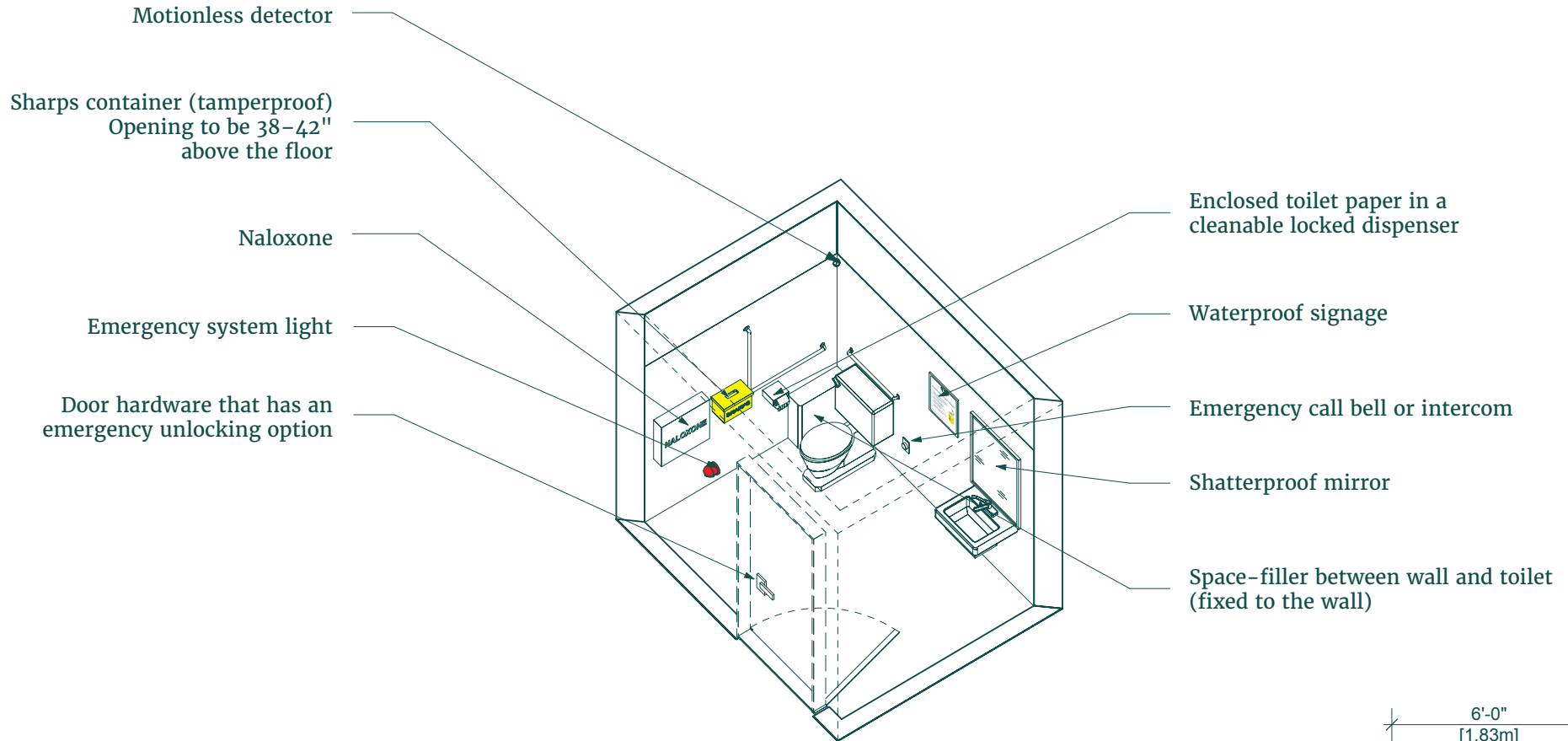

Notes:

All fixture heights, grab bars, door types should conform with local building bylaws.

Items shown pertain to the safer bathroom toolkit, there may be other required items in a bathroom that are not shown here.

Bathroom users should be consulted in design decisions.

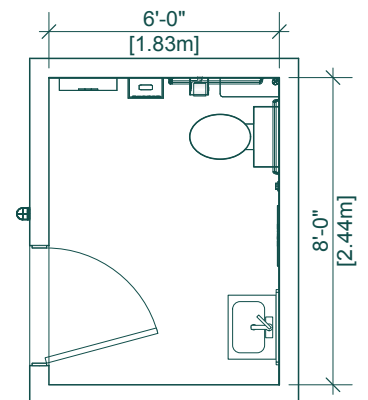

Multi-Stall Bathroom

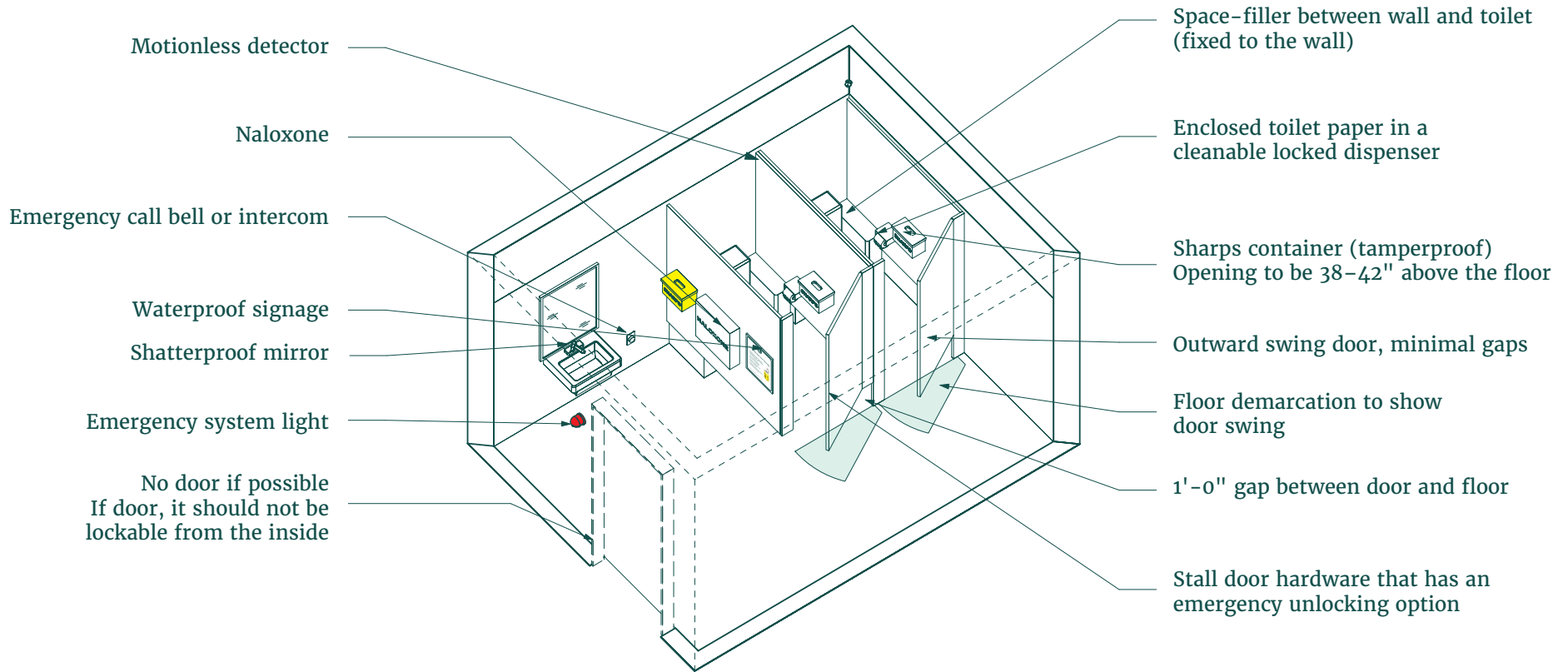

Notes:

All fixture heights, grab bars, door types should conform with local building bylaws.

Items shown pertain to the safer bathroom toolkit, there may be other required items in a bathroom that are not shown here.

Bathroom users should be consulted in design decisions.

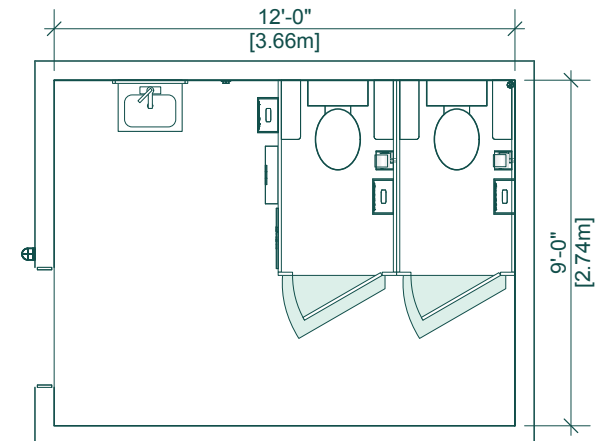

Examples of Safer Bathroom Features

Privacy Lock



Indicator Lock (Model 571)



Removable Door Hinge



Sharps Container



Toilet Paper Dispenser



Examples of Emergency Systems

Motionless Detector



BRAVE Button/Sensor

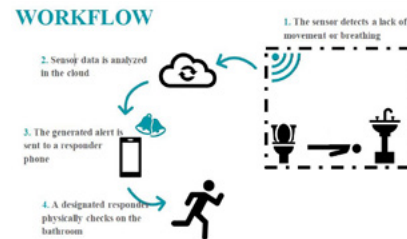

Emergency Call Button/Intercom

